



# SOT-23 Plastic-Encapsulate D]cXYg

## BZX84C2V4-BZX84C43 ZENER DIODE

### FEATURES

- Planar Die Construction
- 300mW Power Dissipation
- Zener Voltages from 2.4V - 43V
- Ultra-Small Surface Mount Package Power Dissipation

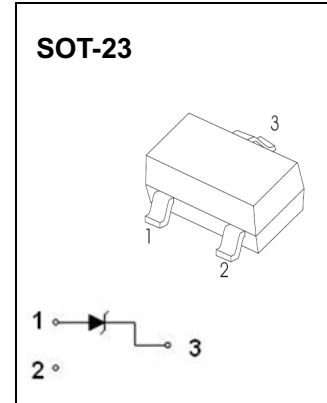

### Maximum Ratings( $T_a=25^\circ\text{C}$ unless otherwise specified)

Characteristic	Symbol	Value	Unit
Forward Voltage (Note 2) @ $I_F = 10\text{mA}$	$V_F$	0.9	V
Power Dissipation(Note 1)	$P_d$	300	mW
Thermal Resistance from Junction to Ambient	$R_{\theta JA}$	417	$^\circ\text{C/W}$
Junction Temperature	$T_j$	150	$^\circ\text{C}$
Storage Temperature Range	$T_{stg}$	-55~+150	$^\circ\text{C}$

# ELECTRICAL CHARACTERISTICS

T<sub>a</sub>=25°C unless otherwise specified

Type Number	Code	Zener Voltage Range (Note 2)				Maximum Zener Impedance (Note 3)			Maximum Reverse Current		Temperature Coefficient of Zener voltage @ I <sub>ZT</sub> =5mA	
		V <sub>Z</sub> @I <sub>ZT</sub>			I <sub>ZT</sub>	Z <sub>ZT</sub> @I <sub>ZT</sub>	Z <sub>ZK</sub> @I <sub>ZK</sub>	I <sub>ZK</sub>	I <sub>R</sub>	V <sub>R</sub>	mV/°C	
		Nom(V)	Min(V)	Max(V)	(mA)	(Ω)		(mA)	(μA)	(V)	Min	Max
BZX84C2V4	Z11	2.4	2.20	2.60	5	100	600	1.0	50	1.0	-3.5	0
BZX84C2V7	Z12	2.7	2.5	2.9	5	100	600	1.0	20	1.0	-3.5	0
BZX84C3V0	Z13	3.0	2.8	3.2	5	95	600	1.0	10	1.0	-3.5	0
BZX84C3V3	Z14	3.3	3.1	3.5	5	95	600	1.0	5	1.0	-3.5	0
BZX84C3V6	Z15	3.6	3.4	3.8	5	90	600	1.0	5	1.0	-3.5	0
BZX84C3V9	Z16	3.9	3.7	4.1	5	90	600	1.0	3	1.0	-3.5	0
BZX84C4V3	Z17	4.3	4.0	4.6	5	90	600	1.0	3	1.0	-3.5	0
BZX84C4V7	Z1	4.7	4.4	5.0	5	80	500	1.0	3	2.0	-3.5	0.2
BZX84C5V1	Z2	5.1	4.8	5.4	5	60	480	1.0	2	2.0	-2.7	1.2
BZX84C5V6	Z3	5.6	5.2	6.0	5	40	400	1.0	1	2.0	-2.0	2.5
BZX84C6V2	Z4	6.2	5.8	6.6	5	10	150	1.0	3	4.0	0.4	3.7
BZX84C6V8	Z5	6.8	6.4	7.2	5	15	80	1.0	2	4.0	1.2	4.5
BZX84C7V5	Z6	7.5	7.0	7.9	5	15	80	1.0	1	5.0	2.5	5.3
BZX84C8V2	Z7	8.2	7.7	8.7	5	15	80	1.0	0.7	5.0	3.2	6.2
BZX84C9V1	Z8	9.1	8.5	9.6	5	15	100	1.0	0.5	6.0	3.8	7.0
BZX84C10	Z9	10	9.4	10.6	5	20	150	1.0	0.2	7.0	4.5	8.0
BZX84C11	Y1•	11	10.4	11.6	5	20	150	1.0	0.1	8.0	5.4	9.0
BZX84C12	Y2•	12	11.4	12.7	5	25	150	1.0	0.1	8.0	6.0	10.0
BZX84C13	Y3	13	12.4	14.1	5	30	170	1.0	0.1	8.0	7.0	11.0
BZX84C15	Y4	15	13.8	15.6	5	30	200	1.0	0.1	10.5	9.2	13.0
BZX84C16	Y5	16	15.3	17.1	5	40	200	1.0	0.1	11.2	10.4	14.0
BZX84C18	Y6	18	16.8	19.1	5	45	225	1.0	0.1	12.6	12.4	16.0
BZX84C20	Y7	20	18.8	21.2	5	55	225	1.0	0.1	14.0	14.4	18.0
BZX84C22	Y8	22	20.8	23.3	5	55	250	1.0	0.1	15.4	16.4	20.0
BZX84C24	Y9	24	22.8	25.6	5	70	250	1.0	0.1	16.8	18.4	22.0
BZX84C27	Y10	27	25.1	28.9	2	80	300	0.5	0.1	18.9	21.4	25.3
BZX84C30	Y11•	30	28.0	32.0	2	80	300	0.5	0.1	21.0	24.4	29.4
BZX84C33	Y12	33	31.0	35.0	2	80	325	0.5	0.1	23.1	27.4	33.4
BZX84C36	Y13	36	34.0	38.0	2	90	350	0.5	0.1	25.2	30.4	37.4
BZX84C39	Y14	39	37.0	41.0	2	130	350	0.5	0.1	27.3	33.4	41.2
BZX84C43	Y15	43	40.0	46.0	2	100	700	1	0.1	32	10	12

- Notes:
1. Valid provided that device terminals are kept at ambient temperature.
  2. Tested with pulses, period=5ms,pulse width =300μs.
  3. f = 1kHz.

# ELECTRICAL CHARACTERISTICS

Zener Characteristics ( $V_z$  Up to 10 V)

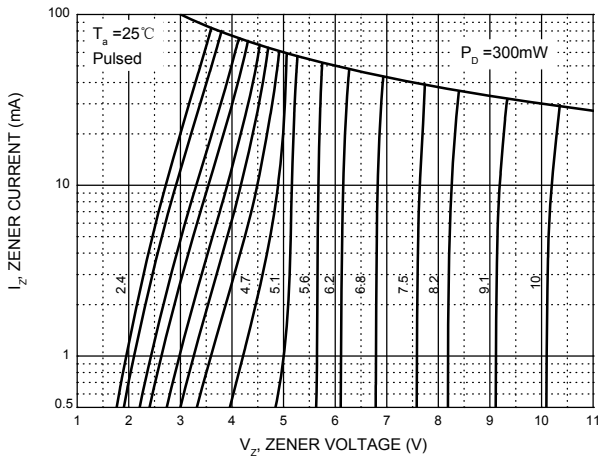

Zener Characteristics (11 V to 43 V)

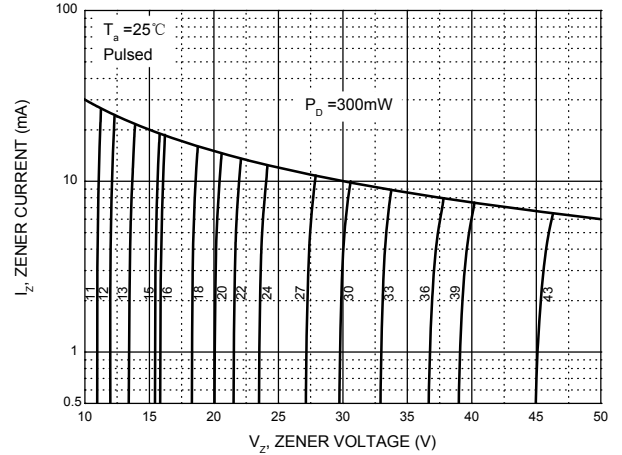

Temperature Coefficients

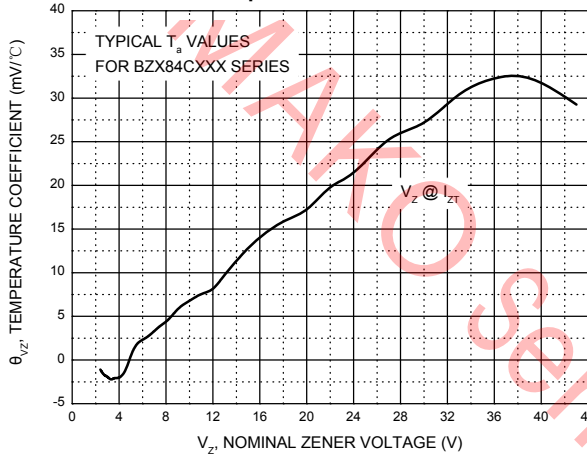

Typical Leakage Current

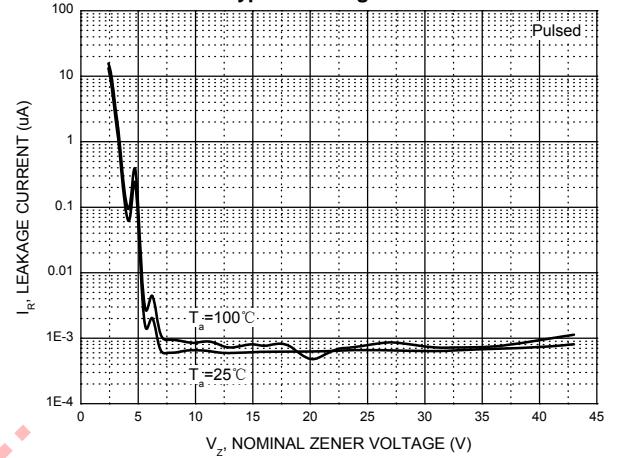

Typical Capacitance

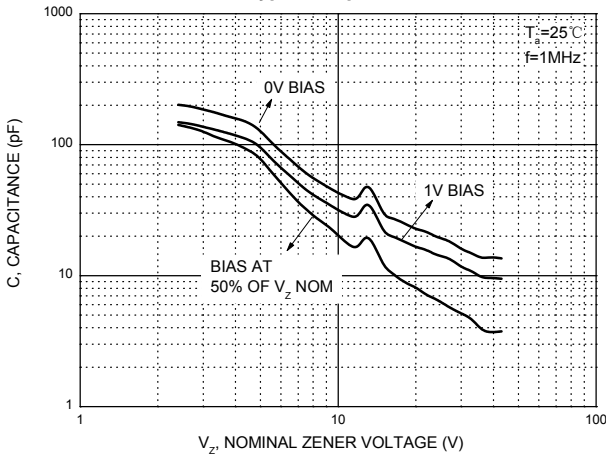

Effect of Zener Voltage on Zener Impedance

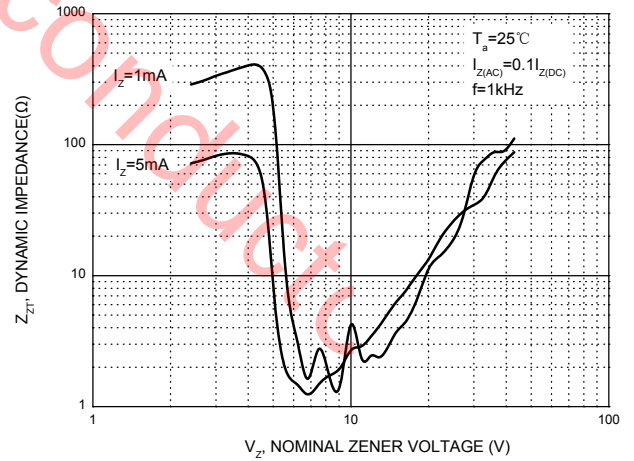

Power Derating Curve

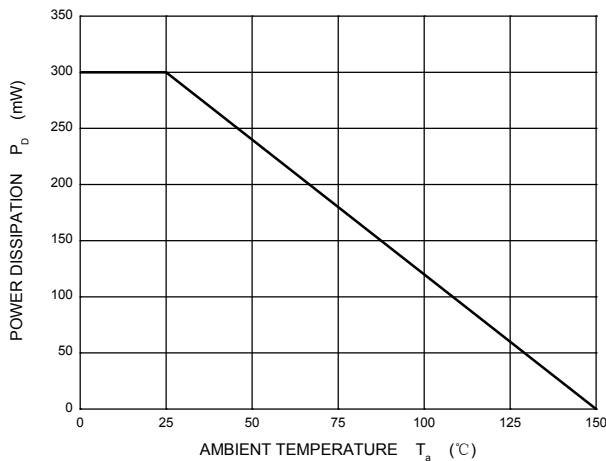

## SOT-23 Package Outline Dimensions

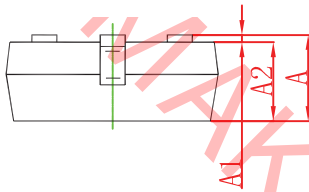
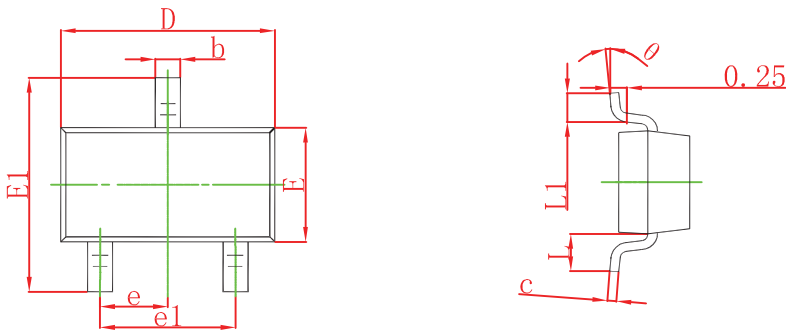

Symbol	Dimensions In Millimeters		Dimensions In Inches	
	Min	Max	Min	Max
A	0.900	1.150	0.035	0.045
A1	0.000	0.100	0.000	0.004
A2	0.900	1.050	0.035	0.041
b	0.300	0.500	0.012	0.020
c	0.080	0.150	0.003	0.006
D	2.800	3.000	0.110	0.118
E	1.200	1.400	0.047	0.055
E1	2.250	2.550	0.089	0.100
e	0.950 TYP		0.037 TYP	
e1	1.800	2.000	0.071	0.079
L	0.550 REF		0.022 REF	
L1	0.300	0.500	0.012	0.020
θ	0°	8°	0°	6°

## SOT-23 Suggested Pad Layout

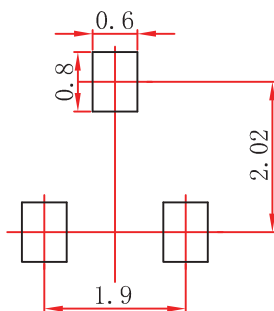

Note:

1. Controlling dimension: in millimeters.
2. General tolerance:  $\pm 0.05\text{mm}$ .
3. The pad layout is for reference purposes only.

### NOTICE

JCET reserve the right to make modifications, enhancements, improvements, corrections or other changes without further notice to any product herein. JCET does not assume any liability arising out of the application or use of any product described herein.

# SOT-23 Tape and Reel

## SOT-23 Embossed Carrier Tape

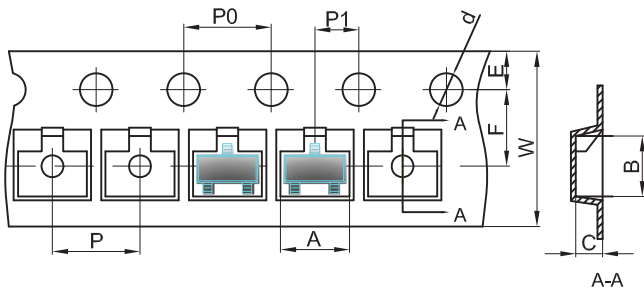

### Packaging Description:

SOT-23 parts are shipped in tape. The carrier tape is made from a dissipative (carbon filled) polycarbonate resin. The cover tape is a multilayer film (Heat Activated Adhesive in nature) primarily composed of polyester film, adhesive layer, sealant, and anti-static sprayed agent. These reeled parts in standard option are shipped with 3,000 units per 7" or 17.8cm diameter reel. The reels are clear in color and is made of polystyrene plastic (anti-static coated).

Dimensions are in millimeter										
Pkg type	A	B	C	d	E	F	P0	P	P1	W
SOT-23	3.15	2.77	1.22	Ø1.50	1.75	3.50	4.00	4.00	2.00	8.00
(Tolerance)	+/-0.1	+/-0.1	+/-0.1	+/-0.1	+/-0.1	+/-0.1	+/-0.1	+/-0.1	+/-0.1	+0.3/-0.1

## SOT-23 Tape Leader and Trailer

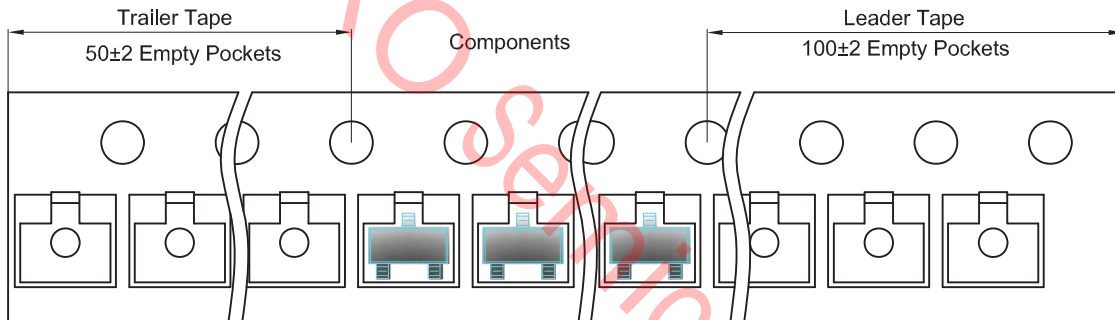

## SOT-23 Reel

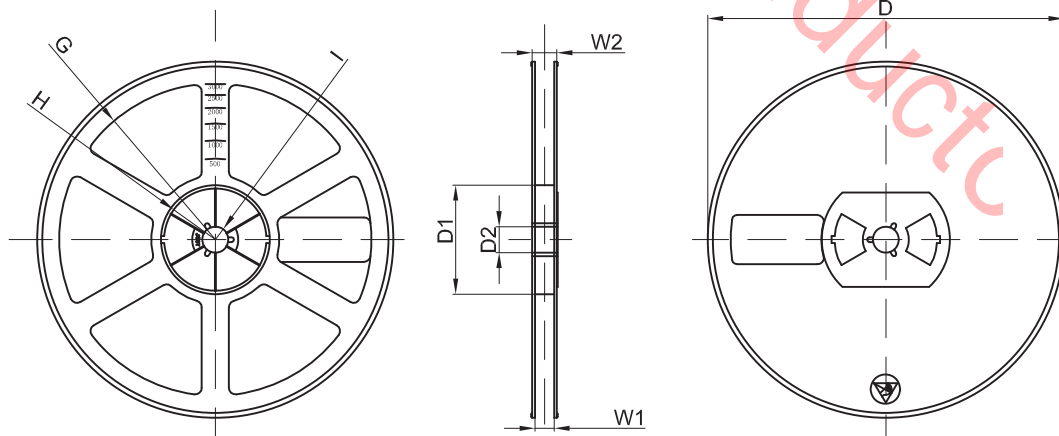

Dimensions are in millimeter								
Reel Option	D	D1	D2	G	H	I	W1	W2
7" Dia	Ø178.00	54.40	13.00	R78.00	R25.60	R6.50	9.50	12.30
Tolerance	+/-2	+/-1	+/-1	+/-1	+/-1	+/-1	+/-1	+/-1

REEL	Reel Size	Box	Box Size(mm)	Carton	Carton Size(mm)	G.W.(kg)
3000 pcs	7 inch	45,000 pcs	203×203×195	180,000 pcs	438×438×220	